

Ficha Técnica

SQUARE WW 2906 92 1200



Optilux

SQUARE WW 2906 92 1200

Optilux

Descripción de producto

- Luminario tipo Wallwasher FIJO de 1 luz para empotrar en plafón falso.
- Cuerpo fabricado en policarbonato.
- Acabados en Negro y Blanco.
- Lente con óptica de: 12° | 24° | 36° de apertura.
- Opción de Potencias: 13.3 W
- Flujo luminoso: desde 970 lm hasta 1,270 lm
- Alta reproducción del color: Ra>90
- Temperaturas de color: 2700 K | 3000 K | 4000 K
- Elevada consistencia del color (MacAdam 3).
- Opciones de control: On/Off | 0-10 V | DALI | bDW
- Vida útil nominal: > 50,000 horas (L70 / F50).
- Garantía de 5 años.
- Garantía de economía circular, lo que permite reemplazar los componentes (Modulo LED y Driver) para su posterior mantenimiento sin cambiar todo el luminario.

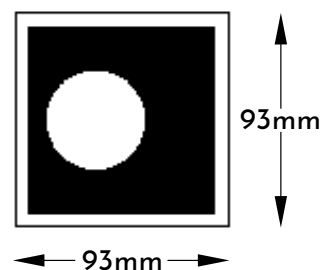
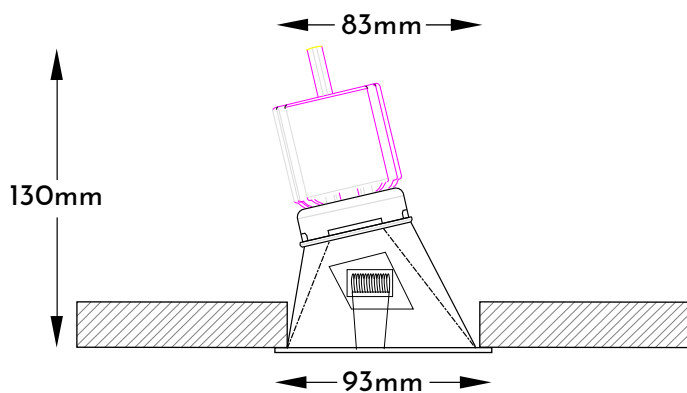

Aplicaciones:

Luz de acento de alta eficiencia y confort visual
Oficinas, hoteles, escuelas y residencial

MÓDULO: SLA DC G2 50mm 1200lm 927-940 SNC

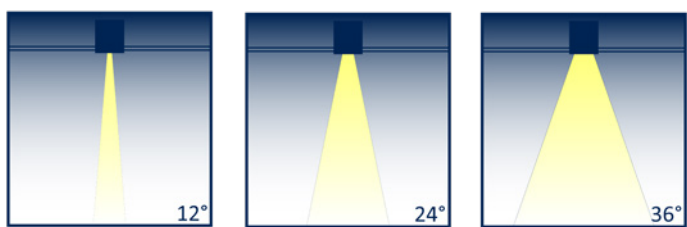

Technology +
TRIDONIC

ERC CE RoHS bDW DALI 0-10V LM79 LM80 NOM IP44 5 años

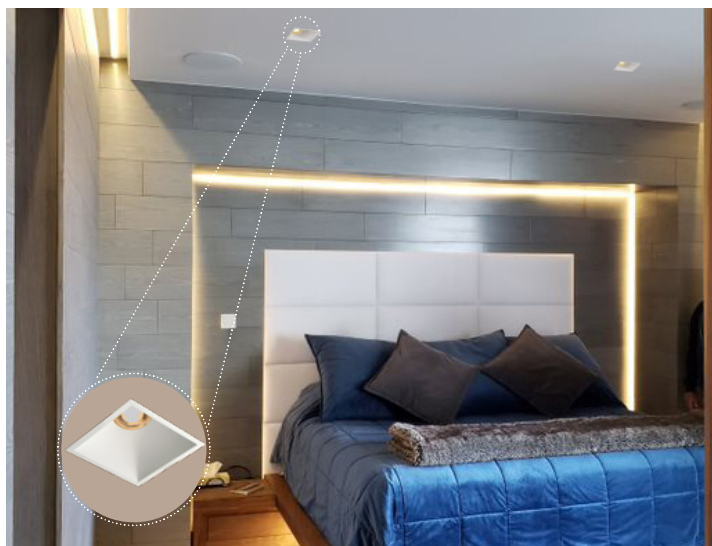

**Características fotométricas:
Coordenadas y tolerancias según CIE 1931**

2,700 k

	x0	y0	
Centre SLA DC G2 1200lm	0.4578	0.4105	-----

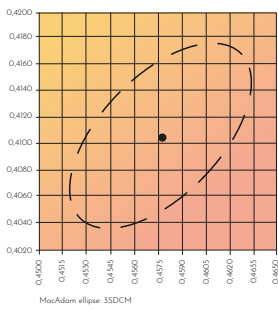

3,000 k

	x0	y0	
Centre SLA DC G2 1200lm	0.4339	0.4036	-----

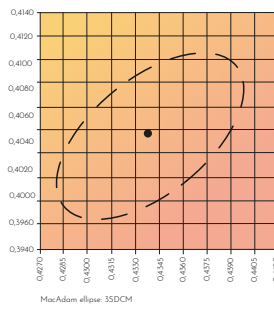

4,000 k

	x0	y0	
Centre SLA DC G2 1200lm	0.3820	0.3804	-----

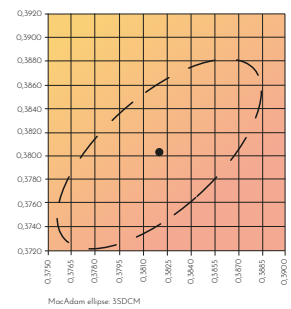

Curva fotometrica 24°
2700K 1140lm

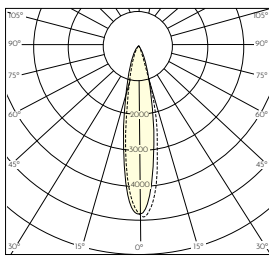

Curva fotometrica 24°
3000K 1170lm

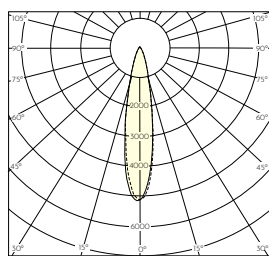

Curva fotometrica 24°
4000K 1270lm

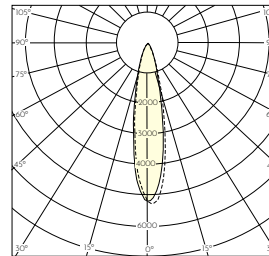

Curva fotometrica 36°
4000K 1270lm

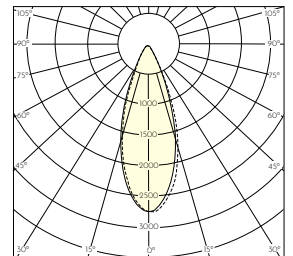

Curva fotometrica 36°
2700K 1140lm

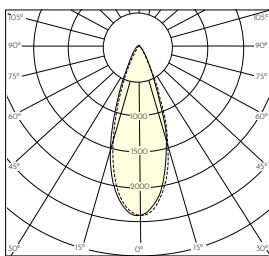

Curva fotometrica 36°
3000K 1170lm

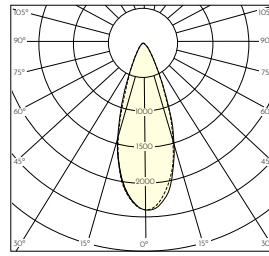

ACABADOS

Curva fotometrica 12°
2700 K | 3000 K | 4000 K
970 lm | 1,140 lm | 1,140 lm

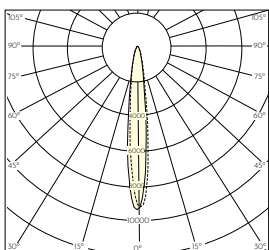

Driver TCI 60-360mA

CONTROL On/Off

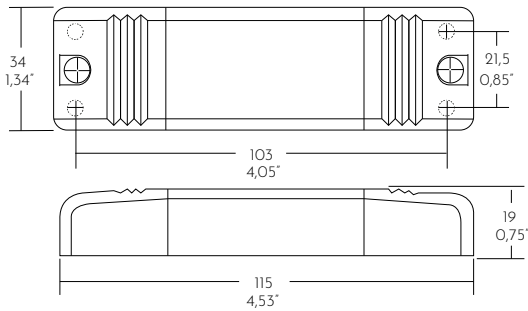

Formación de Código

Código Base	Control	Corriente	T.de Color	IRC	Óptica	Color Luminario
Modelo	On/Off 0	340mA 34	2700K 27	IRC<92	12° 12°	Negro N
	0-10 V 1		3000K 30		24° 24°	Blanco B
	DALI 2		4000K 40		36° 36°	
	basicDIM 3					
LTII612	0	34	27	92	12	B

Datos técnicos

MODELO: CÓDIGO BASE	LTII612									
Código Modulo LED	28002835	28002836	28002837	28001950	28001952	28001954	28001951	28001953	28001955	
Driver	TCI 60-360mA - 127710									
Óptica	12°			24°			36°			
Temperatura de color	2700K	3000K	4000K	2700K	3000K	4000K	2700K	3000K	4000K	
Tolerancia de color (MacAdam)	3SDCM									
Corriente de operación	340mA									
Flujo luminoso del sistema, lm (tp = 65°C)	970 lm	1,040 lm	1,130 lm	1,140 lm	1,170 lm	1,270 lm	1,140 lm	1,170 lm	1,270 lm	
Eficacia del sistema (tp = 65°C)	73 lm/W	78 lm/W	85 lm/W	86 lm/W	88 lm/W	95 lm/W	86 lm/W	88 lm/W	95 lm/W	
Intensidad luminica, cd (tp = 65°C)	6,120 cd	6,540 cd	7,130 cd	4,300 cd	4,400 cd	4,800 cd	2,200 cd	2,300 cd	2,500 cd	
Flujo luminoso del luminario (tp = 65°C)	970 lm	1,040 lm	1,130 lm	1,140 lm	1,170 lm	1,270 lm	1,140 lm	1,170 lm	1,270 lm	
Rendimiento del luminario	73 lm/W	78 lm/W	85 lm/W	86 lm/W	88 lm/W	95 lm/W	86 lm/W	88 lm/W	95 lm/W	
Potencia del sistema	13.3 W									
Reproducción cromática (IRC)	IRC<92									
Interface de control	ON/OFF									
Rango de Atenuación	NO ATENUABLE									
Tensión de alimentación nominal ±10%	100 - 277 V~									
Frecuencia de red	50 / 60 Hz									
Resistencia a la sobretensión	N/A									
Factor de Potencia λ (con 120 V, 60 Hz, plena carga)	N/A									
Factor de Potencia λ (con 277 V, 60 Hz, plena carga)	0.80C									
THD (con 120 V, 60 Hz, plena carga)	N/A									
THD (con 277 V, 60 Hz, plena carga)	< 60 %									
Apto para picos de tensión (entre L/N - PE)	2 kV									
Rango temperatura ambiente del sistema ta	-20 ... +40 °C									
Vida útil nominal (L70/F50)	> 50,000 h									

IP20 SELV

La información descrita en esta ficha esta sujeta a cambios por actualizaciones.

Consulta las ultimas especificaciones con tu asesor.



Diagrama de Conexión

LCO 20/350/57 0-10V C ADV UNV

CONTROL 0-10V

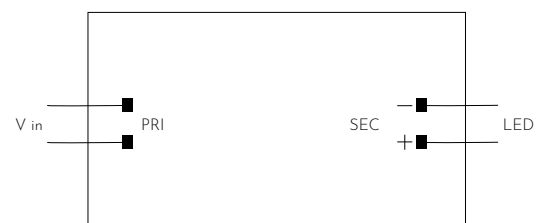
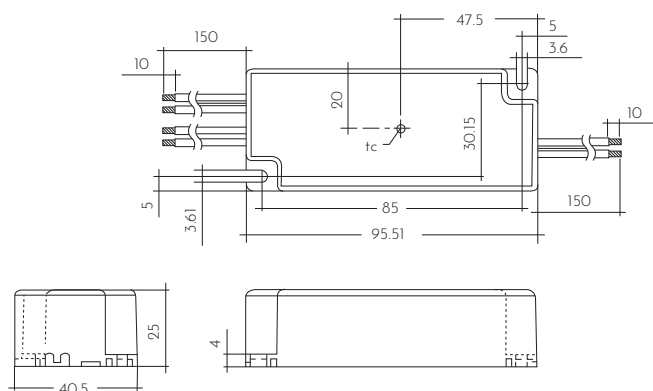

Formación de Código

Código Base	Control	Corriente	T.de Color	IRC	Óptica	Color Luminario
Modelo	On/Off 0 0-10 V 1 DALI 2 basicDIM 3	350mA 35	2700K 27 3000K 30 4000K 40	IRC<92	12° 12° 24° 24° 36° 36°	Negro N Blanco B
LTI1612	1	35	27	92	12	N

Datos técnicos

MODELO: CÓDIGO BASE	LTI1612									
Código Modulo LED	28002835	28002836	28002837	28001950	28001952	28001954	28001951	28001953	28001955	
Driver	LCO 20/350/57 0-10V C ADV UNV - 28002253									
Óptica	12°			24°			36°			
Temperatura de color	2700K	3000K	4000K	2700K	3000K	4000K	2700K	3000K	4000K	
Tolerancia de color (MacAdam)	3SDCM									
Corriente de operación	350mA									
Flujo luminoso del sistema, lm (tp = 65°C)	970 lm	1,040 lm	1,130 lm	1,140 lm	1,170 lm	1,270 lm	1,140 lm	1,170 lm	1,270 lm	
Eficacia del sistema (tp = 65°C)	73 lm/W	78 lm/W	85 lm/W	86 lm/W	88 lm/W	95 lm/W	86 lm/W	88 lm/W	95 lm/W	
Intensidad luminica, cd (tp = 65°C)	6,120 cd	6,540 cd	7,130 cd	4,300 cd	4,400 cd	4,800 cd	2,200 cd	2,300 cd	2,500 cd	
Flujo luminoso del luminario (tp = 65°C)	970 lm	1,040 lm	1,130 lm	1,140 lm	1,170 lm	1,270 lm	1,140 lm	1,170 lm	1,270 lm	
Rendimiento del luminario	73 lm/W	78 lm/W	85 lm/W	86 lm/W	88 lm/W	95 lm/W	86 lm/W	88 lm/W	95 lm/W	
Potencia del sistema	13.3 W									
Reproducción cromática (IRC)	IRC<92									
Interface de control	0-10V									
Rango de Atenuación	10 - 100%									
Tensión de alimentación nominal ±10%	100 - 277 V~									
Frecuencia de red	50 / 60 Hz									
Resistencia a la sobretensión	N/A									
Factor de Potencia λ (con 120 V, 60 Hz, plena carga)	0.98									
Factor de Potencia λ (con 277 V, 60 Hz, plena carga)	0.95									
THD (con 120 V, 60 Hz, plena carga)	< 6 %									
THD (con 277 V, 60 Hz, plena carga)	< 10 %									
Apto para picos de tensión (entre L/N - PE)	2 kV									
Rango temperatura ambiente del sistema ta	-20 ... +40 °C									
Vida útil nominal (L70/F50)	> 50,000 h									



La información descrita en esta ficha esta sujeta a cambios por actualizaciones.

Consulta las ultimas especificaciones con tu asesor.

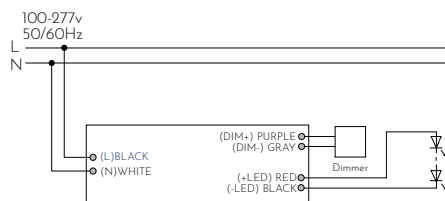

Primary cable	Secondary cable	Dimmer cable
N white	- black	- gray
L black	+ red	+ purple

LCA 17W 250-700mA one4all SC PRE

CONTROL DALI

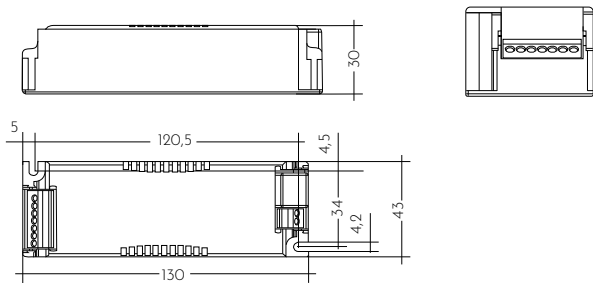

Formación de Código

Código Base	Control	Corriente	T.de Color	IRC	Óptica	Color Luminario
Modelo	On/Off 0	350mA 35	2700K 27	IRC <92	12° 12°	Negro N
	0-10 V 1		3000K 30		24° 24°	Blanco B
	DALI 2		4000K 40		36° 36°	
	basicDIM 3					
LTI1612	2	35	30	92	24	B

Datos técnicos

MODELO: CÓDIGO BASE	LTI1612									
Código Modulo LED	28002835	28002836	28002837	28001950	28001952	28001954	28001951	28001953	28001955	
Driver	LCA 17W 250-700mA one4all SC PRE - 28000674									
Óptica	12°			24°			36°			
Temperatura de color	2700K	3000K	4000K	2700K	3000K	4000K	2700K	3000K	4000K	
Tolerancia de color (MacAdam)	35DCM									
Corriente de operación	350mA									
Flujo luminoso del sistema, lm (tp = 65°C)	970 lm	1,040 lm	1,130 lm	1,140 lm	1,170 lm	1,270 lm	1,140 lm	1,170 lm	1,270 lm	
Eficacia del sistema (tp = 65°C)	73 lm/W	78 lm/W	85 lm/W	86 lm/W	88 lm/W	95 lm/W	86 lm/W	88 lm/W	95 lm/W	
Intensidad luminica, cd (tp = 65°C)	6,120 cd	6,540 cd	7,130 cd	4,300 cd	4,400 cd	4,800 cd	2,200 cd	2,300 cd	2,500 cd	
Flujo luminoso del luminario (tp = 65°C)	970 lm	1,040 lm	1,130 lm	1,140 lm	1,170 lm	1,270 lm	1,140 lm	1,170 lm	1,270 lm	
Rendimiento del luminario	73 lm/W	78 lm/W	85 lm/W	86 lm/W	88 lm/W	95 lm/W	86 lm/W	88 lm/W	95 lm/W	
Potencia del sistema	13.3 W									
Reproducción cromática (IRC)	IRC <92									
Interface de control	one4all (DALI-2 DT 6, DSI, switchDIM, corridorFUNCTION)									
Rango de Atenuación	1 - 100%									
Tensión de alimentación nominal ±10%	220 - 240 V~									
Frecuencia de red	50 / 60 Hz									
Resistencia a la sobretensión	320 V AC, 48 h									
Factor de Potencia λ (con 120 V, 60 Hz, plena carga)	N/A									
Factor de Potencia λ (con 277 V, 60 Hz, plena carga)	0.96									
THD (con 120 V, 60 Hz, plena carga)	N/A									
THD (con 277 V, 60 Hz, plena carga)	< 3 %									
Apto para picos de tensión (entre L/N - PE)	2 kV									
Rango temperatura ambiente del sistema ta	-20 ... +40 °C									
Vida útil nominal (L70/F50)	> 50,000 h									

lumDATA DALI IP20 SELV



La información descrita en esta ficha esta sujeta a cambios por actualizaciones.

Consulta las ultimas especificaciones con tu asesor.



Diagrama de Conexión

SQUARE WW 2906 92 1200

Optilux

LC 17/250-700/50 bDW SC PRE2

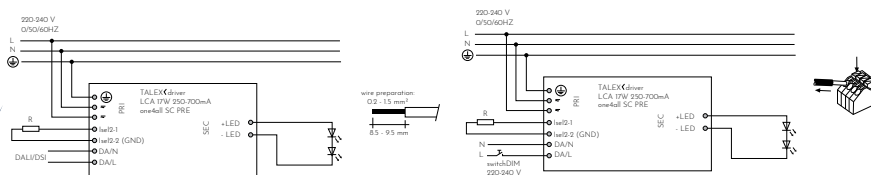
CONTROL basicDIM Wireless

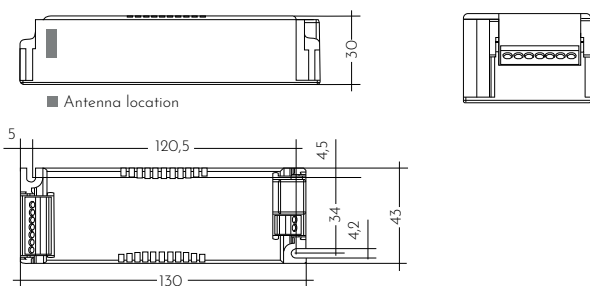

Formación de Código

Código Base	Control	Corriente	T.de Color	IRC	Óptica	Color Luminario
Modelo	On/Off 0	350mA 35	2700K 27	IRC<92	12° 12°	Negro N
	0-10 V 1		3000K 30		24° 24°	Blanco B
	DALI 2		4000K 40		36° 36°	
	basicDIM 3					
LTII612	3	35	40	92	36	B

Datos técnicos

MODELO: CÓDIGO BASE	LTII612									
Código Modulo LED	28002835	28002836	28002837	28001950	28001952	28001954	28001951	28001953	28001955	
Driver	LC 17/250-700/50 bDW SC PRE2 - 28002412									
Óptica	12°			24°			36°			
Temperatura de color	2700K	3000K	4000K	2700K	3000K	4000K	2700K	3000K	4000K	
Tolerancia de color (MacAdam)	3SDCM									
Corriente de operación	350mA									
Flujo luminoso del sistema, lm (tp = 65°C)	970 lm	1,040 lm	1,130 lm	1,140 lm	1,170 lm	1,270 lm	1,140 lm	1,170 lm	1,270 lm	
Eficacia del sistema (tp = 65°C)	73 lm/W	78 lm/W	85 lm/W	86 lm/W	88 lm/W	95 lm/W	86 lm/W	88 lm/W	95 lm/W	
Intensidad luminica, cd (tp = 65°C)	6,120 cd	6,540 cd	7,130 cd	4,300 cd	4,400 cd	4,800 cd	2,200 cd	2,300 cd	2,500 cd	
Flujo luminoso del luminario (tp = 65°C)	970 lm	1,040 lm	1,130 lm	1,140 lm	1,170 lm	1,270 lm	1,140 lm	1,170 lm	1,270 lm	
Rendimiento del luminario	73 lm/W	78 lm/W	85 lm/W	86 lm/W	88 lm/W	95 lm/W	86 lm/W	88 lm/W	95 lm/W	
Potencia del sistema	13.30 W									
Reproducción cromática (IRC)	IRC<92									
Interface de control	basicDIM Wireless									
Rango de Atenuación	1 - 100%									
Tensión de alimentación nominal ±10%	220 - 240 V~									
Frecuencia de red	50 / 60 Hz									
Resistencia a la sobretensión	320 V AC, 48 h									
Factor de Potencia λ (con 120 V, 60 Hz, plena carga)	N/A									
Factor de Potencia λ (con 277 V, 60 Hz, plena carga)	0.96									
THD (con 120 V, 60 Hz, plena carga)	N/A									
THD (con 277 V, 60 Hz, plena carga)	< 3 %									
Apto para picos de tensión (entre L/N - PE)	2 kV									
Rango temperatura ambiente del sistema ta	-20 ... +40 °C									
Vida útil nominal (L70/F50)	> 50,000 h									

IP20 SELV

La información descrita en esta ficha esta sujeta a cambios por actualizaciones.

Consulta las ultimas especificaciones con tu asesor.



Diagrama de Conexión

Optilux

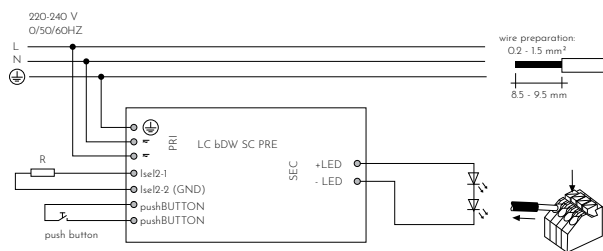
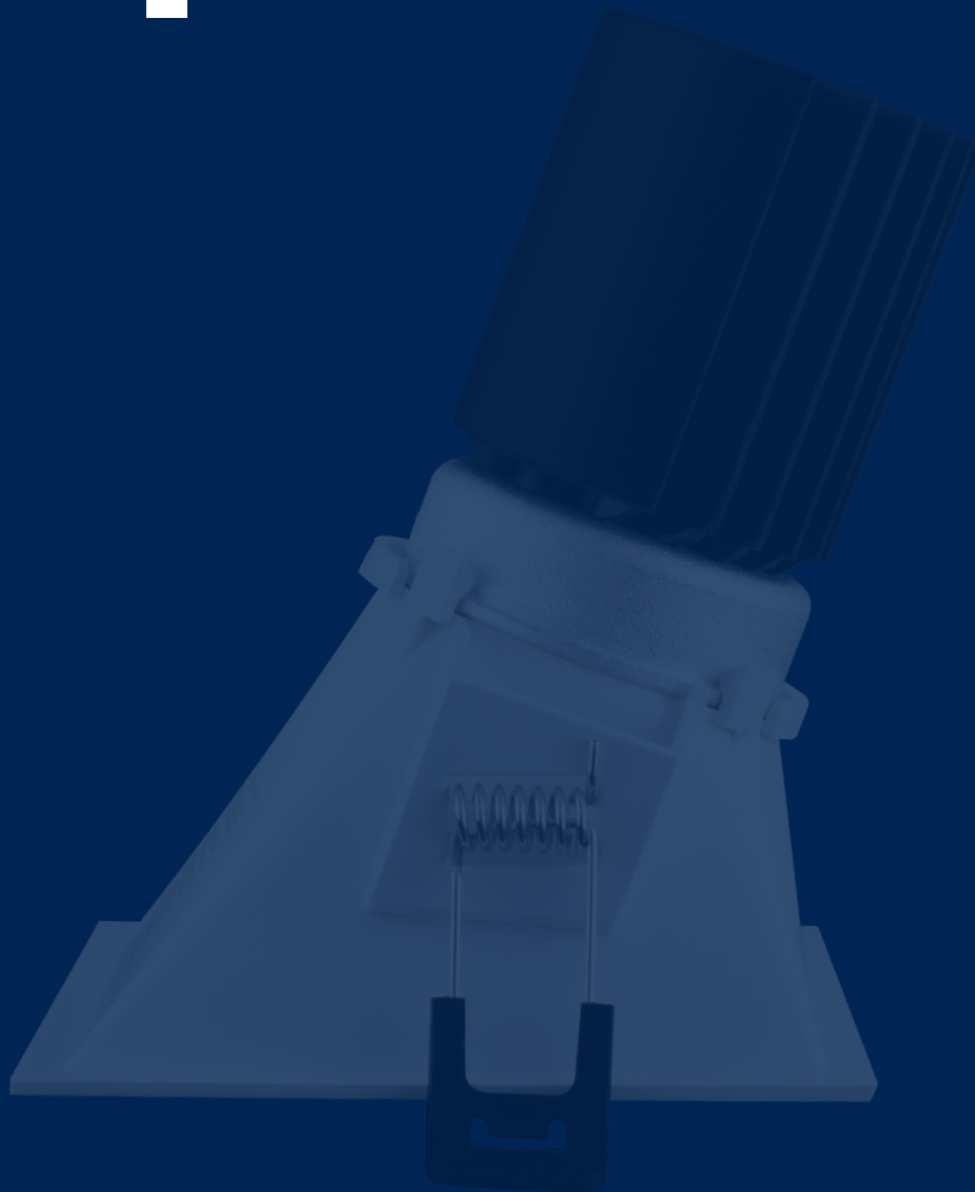

contacto@optilux.mx

Tel: 55-9133-3136



Síguenos en: [@optiluxmx](https://www.instagram.com/optiluxmx)