

Ficha Técnica

SQUARE CONFORT 3004 92 700

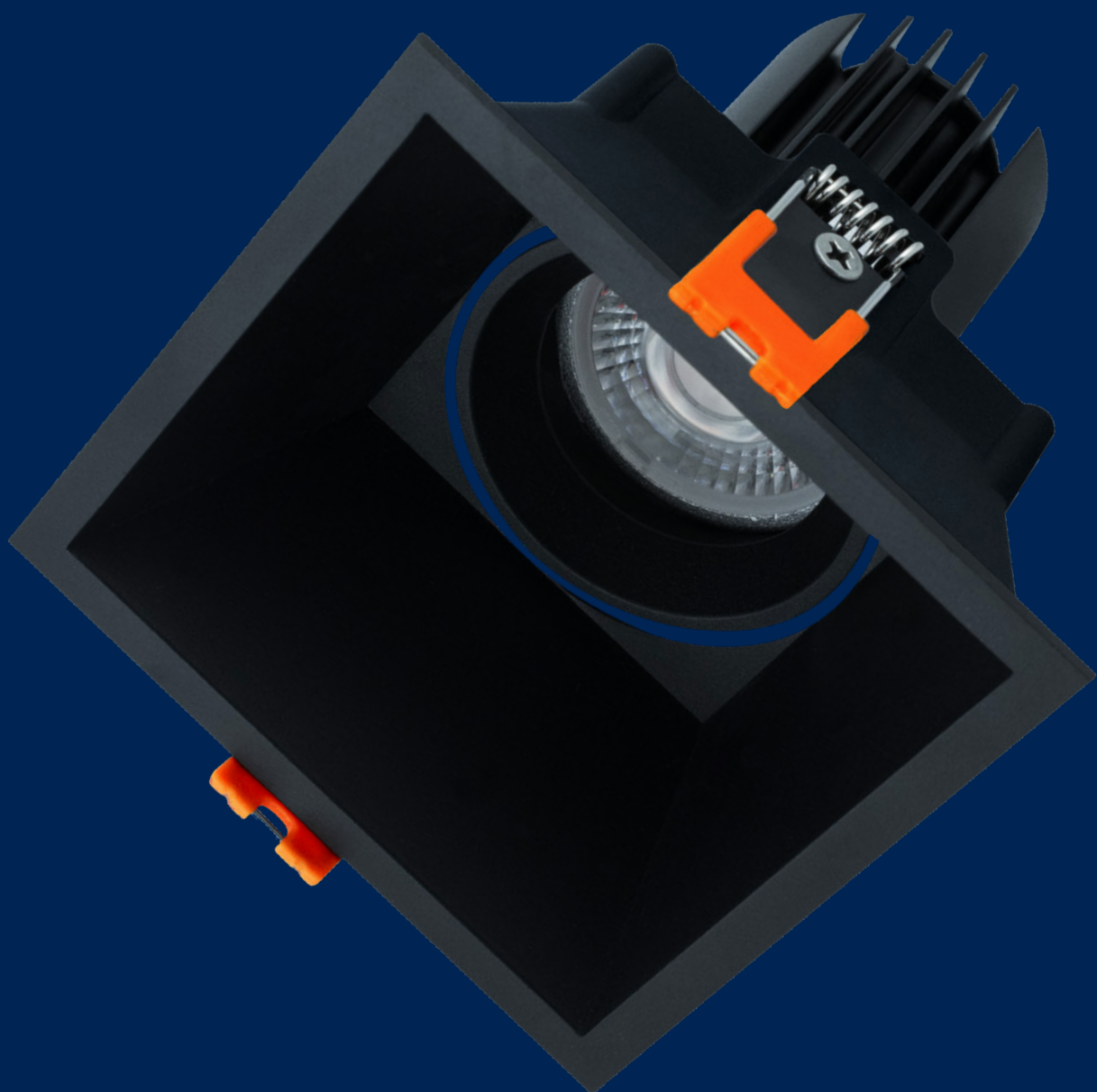

Optilux

Descripción de producto

- Luminario tipo spot DIRIGIBLE de 1 luz para empotrar en plafón falso.
- Cuerpo fabricado en inyección de aluminio.
- Acabados en Negro y Blanco.
- Lente con óptica de: 24° | 36° de apertura.
- Opción de Potencias: 10.4 W
- Flujo luminoso: desde 770 lm hasta 890 lm
- Alta reproducción del color: Ra>90
- Temperaturas de color: 2700 K | 3000 K | 4000 K
- Elevada consistencia del color (MacAdam 3).
- Opciones de control: On/Off | 0-10 V | DALI | bDW
- Vida útil nominal: > 50,000 horas (L70 / F50)
- Garantía de 5 años.
- Garantía de economía circular, lo que permite reemplazar los componentes (Modulo LED y Driver) para su posterior mantenimiento sin cambiar todo el luminario.

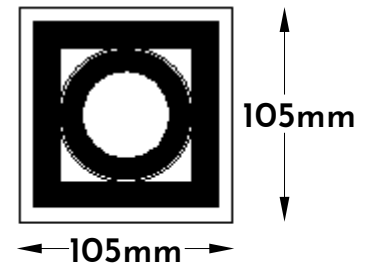
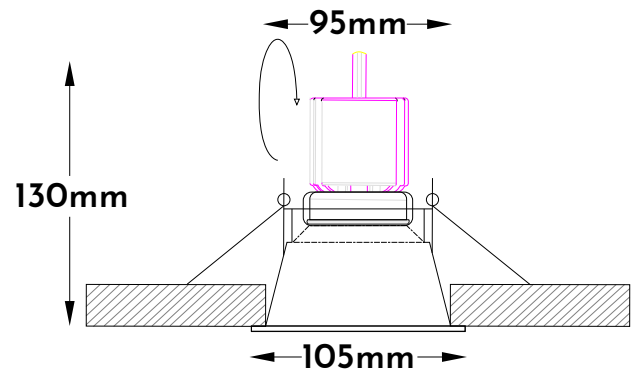

Aplicaciones:

Luz de acento de alta eficiencia y confort visual
Oficinas, hoteles, escuelas y residencial

MÓDULO: SLA DC G2 50mm 700lm 927-940 SNC

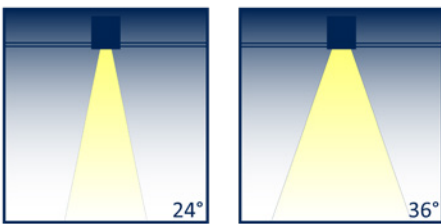

Technology +
TRIDONIC

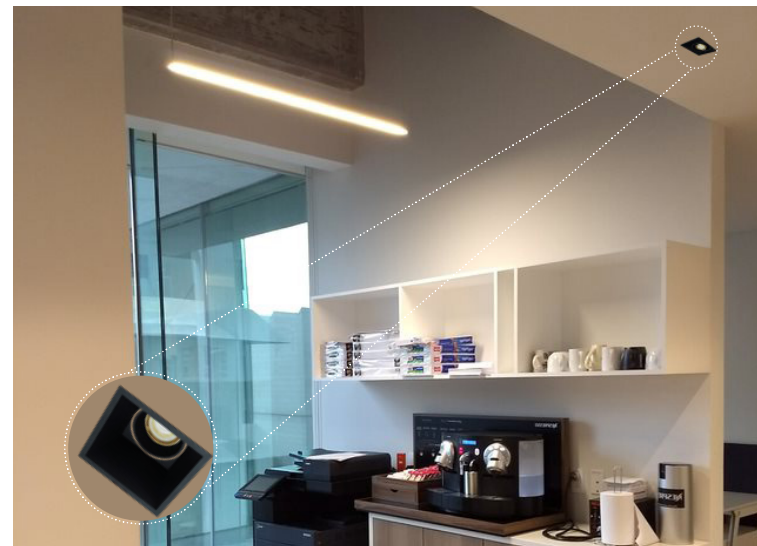
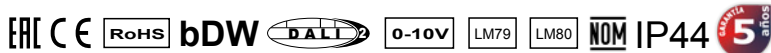

Características fotométricas: Coordenadas y tolerancias según CIE 1931

2,700 k

	x0	y0	
Centre SLA DC G2 700lm	0.4579	0.4114	_____

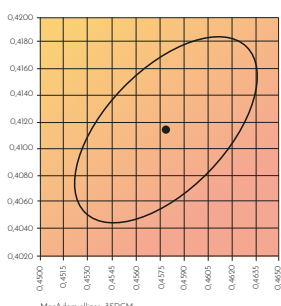

3,000 k

	x0	y0	
Centre SLA DC G2 700lm	0.4341	0.4047	_____

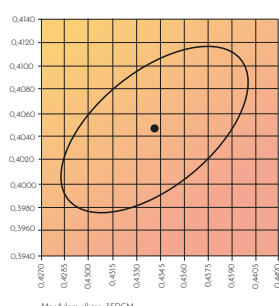

4,000 k

	x0	y0	
Centre SLA DC G2 700lm	0.3825	0.3817	_____

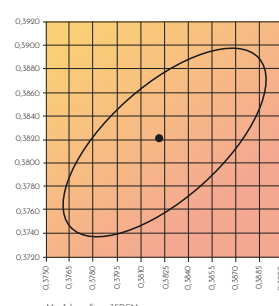

Curva fotométrica 24°
2700K 770lm

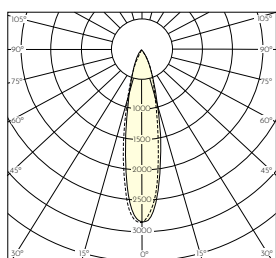

Curva fotométrica 36°
2700K 770lm

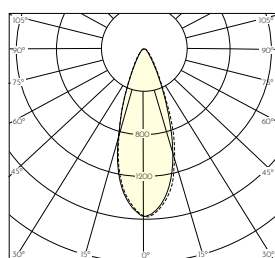

Curva fotométrica 24°
3000K 840lm

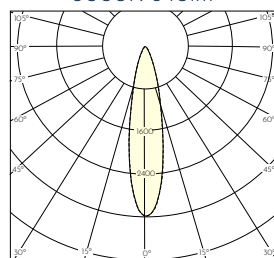

Curva fotométrica 36°
3000K 840lm

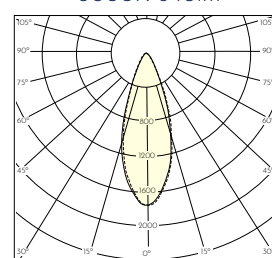

Curva fotométrica 24°
4000K 890lm

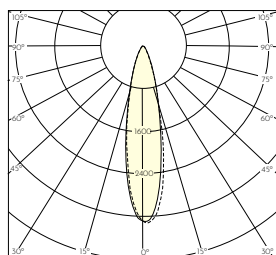

Curva fotométrica 36°
4000K 890lm

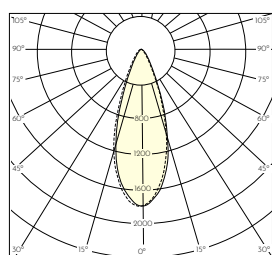

ACABADOS



Negro



Blanco

Driver TCI 60-360mA

CONTROL On/Off

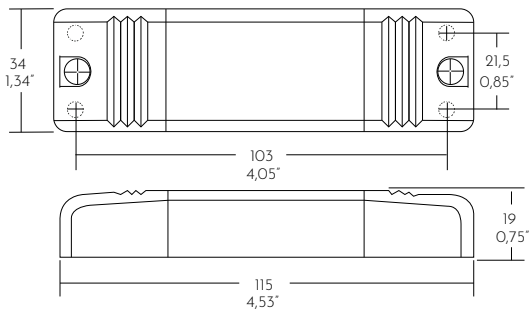

Formación de Código

Código Base	Control	Corriente	T.de Color	IRC	Óptica	Color Luminario
Modelo	On/Off 0	260mA 26	2700K 27	IRC<92	24° 24°	Negro N
	0-10 V 1		3000K 30		36° 36°	Blanco B
	DALI 2		4000K 40			
	basicDIM 3					
LTIII74	0	26	27	92	24	B

Datos técnicos

MODELO: CÓDIGO BASE	LTIII74					
Código Modulo LED	28001942	28001944	28001946	28001943	28001945	28001947
Driver	TCI 60-360mA - 127710					
Óptica	24°			36°		
Temperatura de color	2700K	3000K	4000K	2700K	3000K	4000K
Tolerancia de color (MacAdam)	3SDCM					
Corriente de operación	260mA					
Flujo luminoso del sistema, lm (tp = 65°C)	770 lm	840 lm	890 lm	770 lm	840 lm	890 lm
Eficacia del sistema (tp = 65°C)	74 lm/W	81 lm/W	85 lm/W	74 lm/W	81 lm/W	85 lm/W
Intensidad luminica, cd (tp = 65°C)	2,920 cd	3,190 cd	3,380 cd	1,540 cd	1,680 cd	1,780 cd
Flujo luminoso del luminario (tp = 65°C)	770 lm	840 lm	890 lm	770 lm	840 lm	890 lm
Rendimiento del luminario	74 lm/W	81 lm/W	85 lm/W	74 lm/W	81 lm/W	85 lm/W
Potencia del sistema	104 W					
Reproducción cromática (IRC)	IRC<92					
Interface de control	ON/OFF					
Rango de Atenuación	NO ATENUABLE					
Tensión de alimentación nominal +10%	100 - 277 V~					
Frecuencia de red	50 / 60 Hz					
Resistencia a la sobretensión	N/A					
Factor de Potenciaλ (con 120 V, 60 Hz, plena carga)	N/A					
Factor de Potenciaλ (con 277 V, 60 Hz, plena carga)	0.80C					
THD (con 120 V, 60 Hz, plena carga)	NA					
THD (con 277 V, 60 Hz, plena carga)	≤ 60 %					
Apto para picos de tensión (entre L/N - PE)	2 kV					
Rango temperatura ambiente del sistema ta	-20 ... +40 °C					
Vida útil nominal (L70/F50)	> 50,000 h					

IP20 SELV

La información descrita en esta ficha esta sujeta a cambios por actualizaciones.

Consulta las ultimas especificaciones con tu asesor.



Diagrama de Conexión

LCO 12/250/48 0-10V C ADV UNV

CONTROL 0-10V

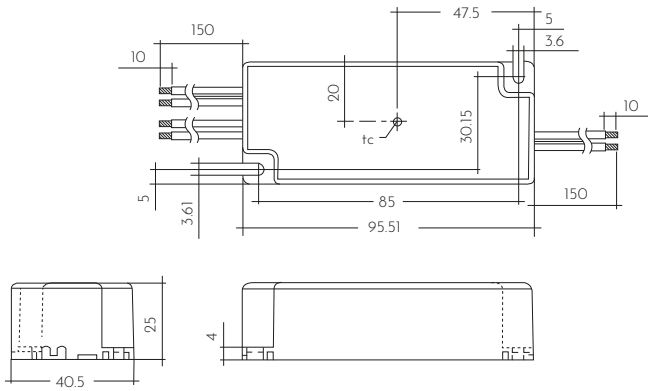

Formación de Código

Código Base	Control	Corriente	T.de Color	IRC	Óptica	Color Luminario
Modelo	On/Off 0	250mA 25	2700K 27	IRC<92	24° 24°	Negro N
	0-10 V 1		3000K 30		36° 36°	Blanco B
	DALI 2		4000K 40			
	basicDIM 3					
LT11174	1	25	27	92	24	N

Datos técnicos

MODELO: CÓDIGO BASE	LT11174					
Código Modulo LED	28001942	28001944	28001946	28001943	28001945	28001947
Driver	LCO 12/250/48 0-10V C ADV UNV - 28002583					
Óptica	24°			36°		
Temperatura de color	2700K	3000K	4000K	2700K	3000K	4000K
Tolerancia de color (MacAdam)	3SDCM					
Corriente de operación	250mA					
Flujo luminoso del sistema, lm (tp = 65°C)	770 lm	840 lm	890 lm	770 lm	840 lm	890 lm
Eficacia del sistema (tp = 65°C)	74 lm/W	81 lm/W	85 lm/W	74 lm/W	81 lm/W	85 lm/W
Intensidad luminica, cd (tp = 65°C)	2,920 cd	3,190 cd	3,380 cd	1,540 cd	1,680 cd	1,780 cd
Flujo luminoso del luminario (tp = 65°C)	770 lm	840 lm	890 lm	770 lm	840 lm	890 lm
Rendimiento del luminario	74 lm/W	81 lm/W	85 lm/W	74 lm/W	81 lm/W	85 lm/W
Potencia del sistema	10.4 W					
Reproducción cromática (IRC)	IRC<92					
Interface de control	0-10V					
Rango de Atenuación	10 - 100%					
Tensión de alimentación nominal ±10%	100 - 277 V~					
Frecuencia de red	50 / 60 Hz					
Resistencia a la sobretensión	N/A					
Factor de Potencia λ (con 120 V, 60 Hz, plena carga)	0.98					
Factor de Potencia λ (con 277 V, 60 Hz, plena carga)	0.95					
THD (con 120 V, 60 Hz, plena carga)	< 5 %					
THD (con 277 V, 60 Hz, plena carga)	< 8 %					
Apto para picos de tensión (entre L/N - PE)	2 kV					
Rango temperatura ambiente del sistema ta	-20 ... +40 °C					
Vida útil promedio (L70 / F10)	> 50,000 h					



La información descrita en esta ficha esta sujeta a cambios por actualizaciones.

Consulta las ultimas especificaciones con tu asesor.

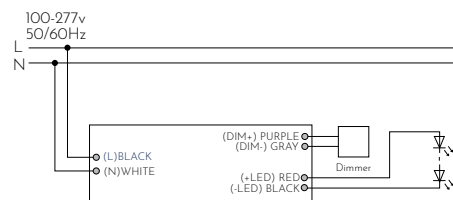

Primary cable		Secondary cable		Dimmer cable	
N	L	-	+	-	+
white	black	black	red	gray	purple

Diagrama de Conexión

LCA 17W 250-700mA one4all SC PRE

CONTROL DALI

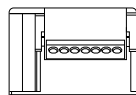
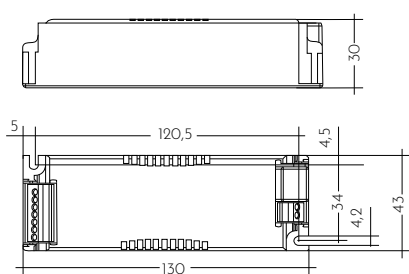

Formación de Código

Código Base	Control	Corriente	T.de Color	IRC	Óptica	Color Luminario
Modelo	On/Off 0 0-10 V 1 DALI 2 basicDIM 3	250mA 25	2700K 27 3000K 30 4000K 40	IRC<92	24° 24° 36° 36°	Negro N Blanco B
LT11174	2	25	30	92	36	B

Datos técnicos

MODELO: CÓDIGO BASE	LT11174					
Código Modulo LED	28001942	28001944	28001946	28001943	28001945	28001947
Driver	LCA 17W 250-700mA one4all SC PRE - 28000674					
Óptica	24°			36°		
Temperatura de color	2700K	3000K	4000K	2700K	3000K	4000K
Tolerancia de color (MacAdam)	3SDCM					
Corriente de operación	250mA					
Flujo luminoso del sistema, lm (tp = 65°C)	770 lm	840 lm	890 lm	770 lm	840 lm	890 lm
Eficacia del sistema (tp = 65°C)	74 lm/W	81 lm/W	85 lm/W	74 lm/W	81 lm/W	85 lm/W
Intensidad luminica, cd (tp = 65°C)	2,920 cd	3,190 cd	3,380 cd	1,540 cd	1,680 cd	1,780 cd
Flujo luminoso del luminario (tp = 65°C)	770 lm	840 lm	890 lm	770 lm	840 lm	890 lm
Rendimiento del luminario	74 lm/W	81 lm/W	85 lm/W	74 lm/W	81 lm/W	85 lm/W
Potencia del sistema	10.4 W					
Reproducción cromática (IRC)	IRC<92					
Interface de control	one4all (DALI-2 DT 6, DSI, switchDIM, corredorFUNCTION)					
Rango de Atenuación	1 - 100%					
Tensión de alimentación nominal ±10%	220 - 240 V~					
Frecuencia de red	50 / 60 Hz					
Resistencia a la sobretensión	320 V AC, 48 h					
Factor de Potencia λ (con 120 V, 60 Hz, plena carga)	N/A					
Factor de Potencia λ (con 230 V, 60 Hz, plena carga)	0.96					
THD (con 120 V, 60 Hz, plena carga)	N/A					
THD (con 230 V, 60 Hz, plena carga)	< 3 %					
Apto para picos de tensión (entre L/N - PE)	2 kV					
Rango temperatura ambiente del sistema ta	-20 ... +40 °C					
Vida útil nominal (L70/F50)	> 50,000 h					

lumDATA IP20

La información descrita en esta ficha esta sujeta a cambios por actualizaciones.

Consulta las ultimas especificaciones con tu asesor.

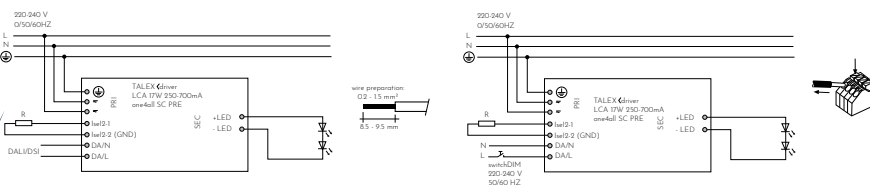

LC 17/250-700/50 bDW SC PRE2

CONTROL basicDIM Wireless

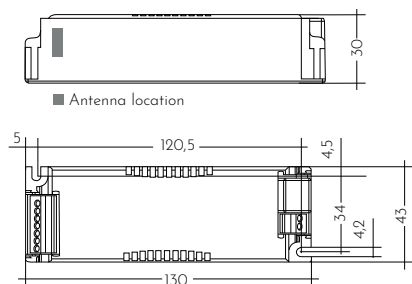

Formación de Código

Código Base	Control	Corriente	T.de Color	IRC	Óptica	Color Luminario
Modelo	On/Off 0	250mA 25	2700K 27	IRC<92	24° 24°	Negro N
	0-10 V 1		3000K 30		36° 36°	Blanco B
	DALI 2		4000K 40			
	basicDIM 3					
LT11174	3	25	40	92	36	B

Datos técnicos

MODELO: CÓDIGO BASE	LT11174					
Código Modulo LED	28001942	28001944	28001946	28001943	28001945	28001947
Driver	LC 17/250-700/50 bDW SC PRE2 - 28002412					
Óptica	24°			36°		
Temperatura de color	2700K	3000K	4000K	2700K	3000K	4000K
Tolerancia de color (MacAdam)	3SDCM					
Corriente de operación	250mA					
Flujo luminoso del sistema, lm (tp = 65°C)	770 lm	840 lm	890 lm	770 lm	840 lm	890 lm
Eficacia del sistema (tp = 65°C)	74 lm/W	81 lm/W	85 lm/W	74 lm/W	81 lm/W	85 lm/W
Intensidad luminica, cd (tp = 65°C)	2,920 cd	3,190 cd	3,380 cd	1,540 cd	1,680 cd	1,780 cd
Flujo luminoso del luminario (tp = 65°C)	770 lm	840 lm	890 lm	770 lm	840 lm	890 lm
Rendimiento del luminario	74 lm/W	81 lm/W	85 lm/W	74 lm/W	81 lm/W	85 lm/W
Potencia del sistema	10,4 W					
Reproducción cromática (IRC)	IRC<92					
Interface de control	basicDIM Wireless					
Rango de Atenuación	1 - 100%					
Tensión de alimentación nominal ±10%	220 - 240 V~					
Frecuencia de red	50 / 60 Hz					
Resistencia a la sobretensión	320 V AC, 48 h					
Factor de Potencia λ (con 120 V, 60 Hz, plena carga)	N/A					
Factor de Potencia λ (con 230 V, 60 Hz, plena carga)	0,96					
THD (con 120 V, 60 Hz, plena carga)	N/A					
THD (con 230 V, 60 Hz, plena carga)	< 3 %					
Apto para picos de tensión (entre L/N - PE)	2 kV					
Rango temperatura ambiente del sistema ta	-20 ... +40 °C					
Vida útil nominal (L70/F50)	> 50,000 h					

IP20 SELV

La información descrita en esta ficha esta sujeta a cambios por actualizaciones.

Consulta las ultimas especificaciones con tu asesor.

Technology +
TRIDONIC



Diagrama de Conexión

Optilux

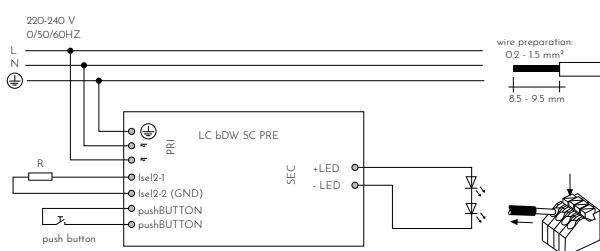
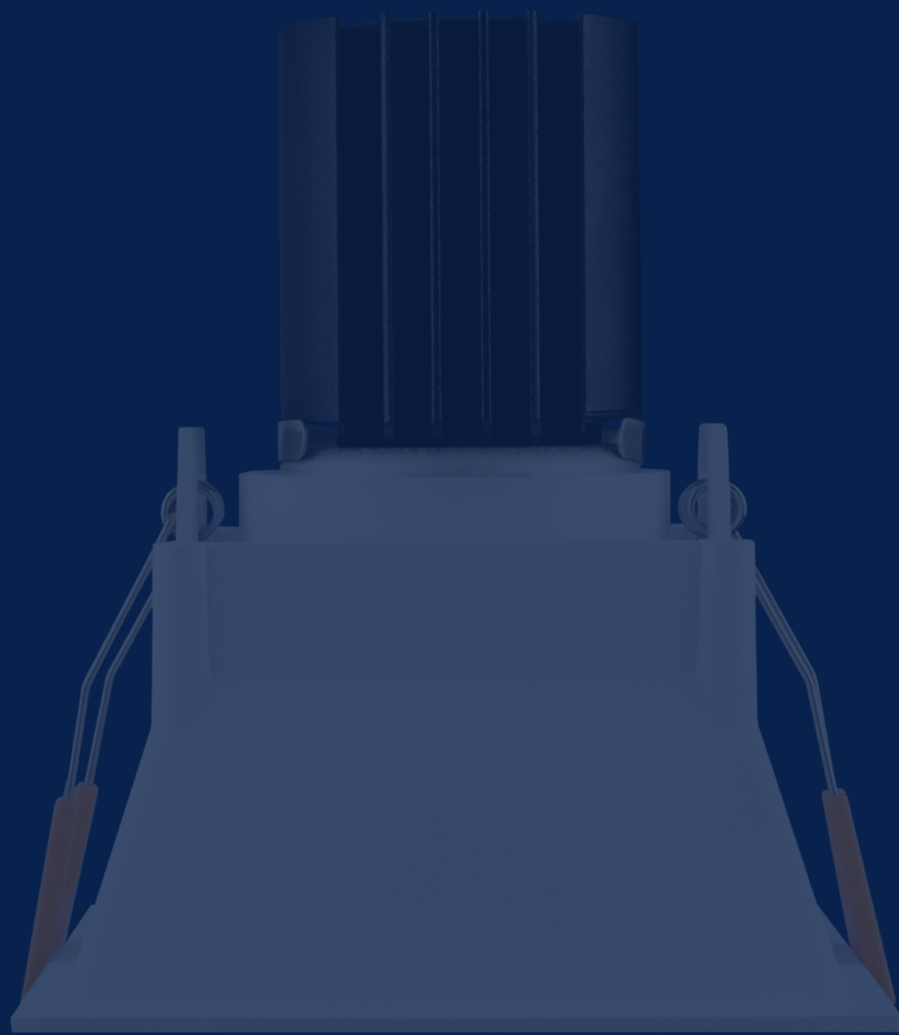

contacto@optilux.mx

Tel: 55-9133-3136



Síguenos en: [@optiluxmx](https://www.instagram.com/optiluxmx)