

# Ficha Técnica

DARK LINE SP 28 90



Optilux®

## Descripción de producto

- Luminario DARK LINE SP 28 90 con UGR <19  
Tipo downlight para suspender en techo.
- Cuerpo fabricado en aluminio extruido, acabados en Anodizado Natural, Blanco y Negro.
- Louver antideslumbrante de 28 luces tipo DARK con varios acabados.
- Lente con óptica de: 35° | 50° | 80°  
~25 + 70° HAZ OVALADO  
Y ASIMETRICO ZT25-D TIPO WALL WASHER
- Opción de Potencias: 30.2 W y 36.5 W en 0-10V  
21.4 W y 43.2 W en DALI e bDW inalámbrico
- Flujo luminoso: 3,033 lm hasta 5,446 lm (3000 K)  
desde 3,166 lm hasta 5,999 lm (4000 K)
- Alta reproducción del color: Ra>90
- Temperaturas de color: 3000 K | 4000 K
- Elevada consistencia del color (MacAdam 3).
- Opciones de control: 0-10V | DALI | bDW
- Vida útil nominal: > 72,000 horas (L80 / F10).
- Garantía de 5 años.
- Garantía de economía circular, lo que permite reemplazar los componentes (Modulo LED y Driver) para su posterior mantenimiento sin cambiar todo el luminario.

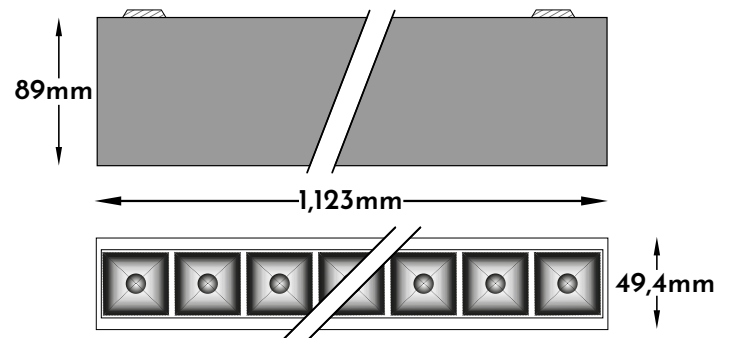

## Aplicaciones:

Luz media y difusa de alta eficiencia y confort visual  
Oficinas, hoteles, escuelas y residencial.

2X LLE 24X560mm 1500lm 930 LVD ADV1  
2X LLE 24X560mm 1500lm 940 LVD ADV1

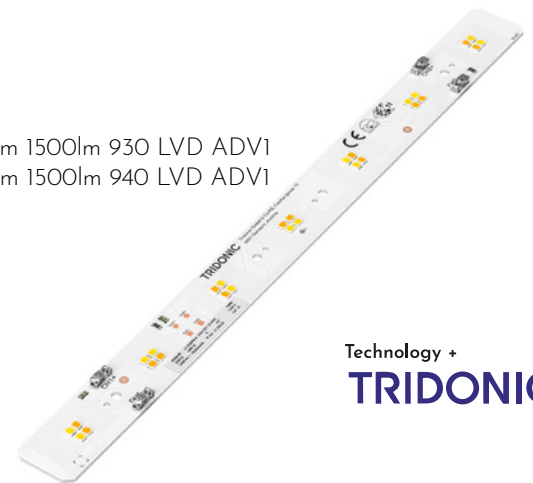

Technology +  
**TRIDONIC**

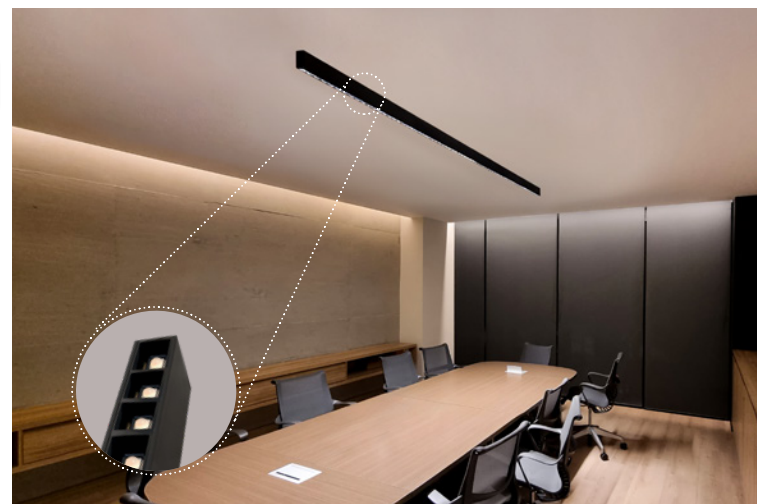

Proyecto SACMAG

ACABADOS

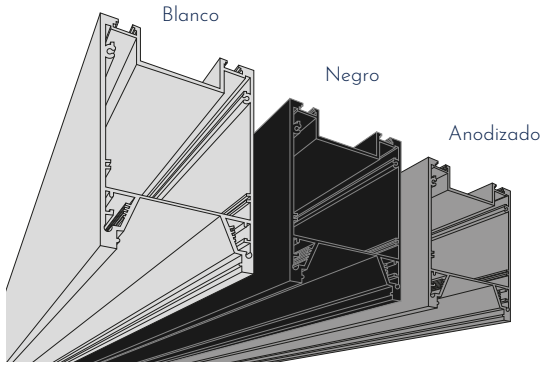

REFLECTORES

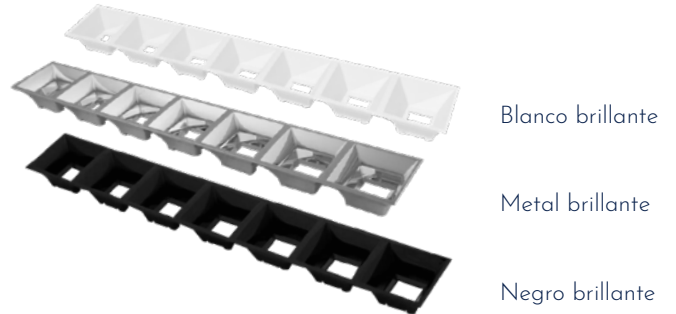

CURVAS FOTOMÉTRICAS:

35° Reflector Negro

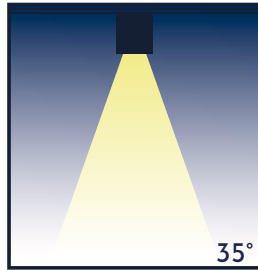
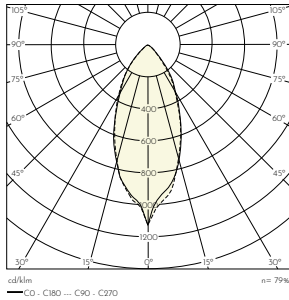

50° Reflector Negro

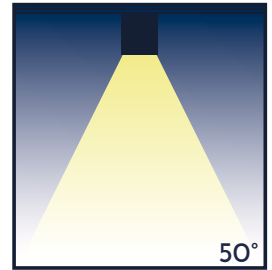
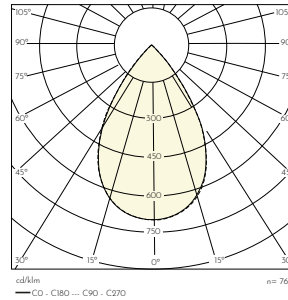

80° Reflector Negro

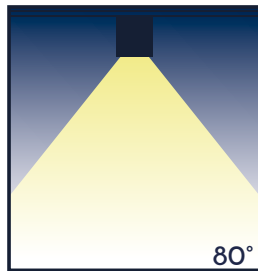
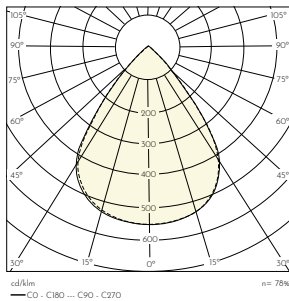

~25 + 70° Haz Ovalado  
° Reflector Negro

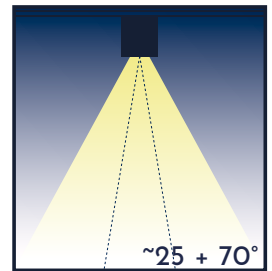
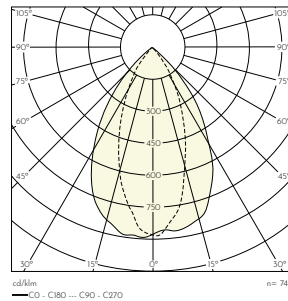

ZT25 Asimetrica  
Reflector Negro

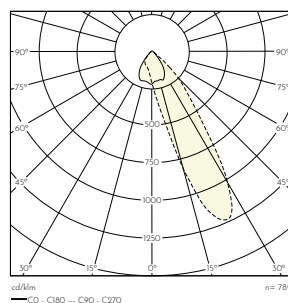

## Coordenadas y Tolerancias según CIE 1931

### 3,000 k

	x0	y0
Center	0.4338	0.4030

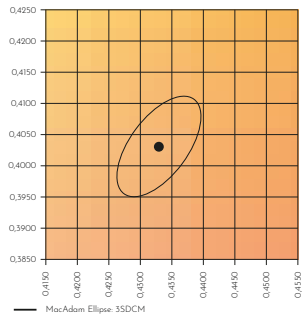

### 4,000 k

	x0	y0
Center	0.3818	0.3797

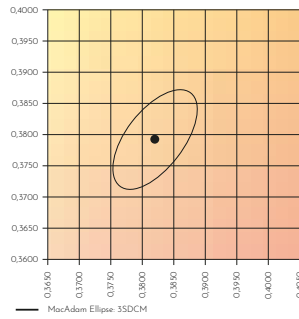

## Nivel de saturación

### 3,000 k

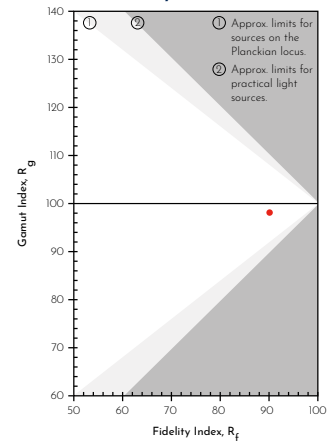

### 4,000 k

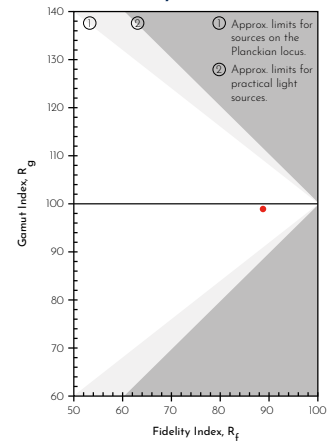

## Gráfico vectorial de color

### 3,000 k

TM30		CRI	
RFR	g	Ra	R9
90	98	92	57

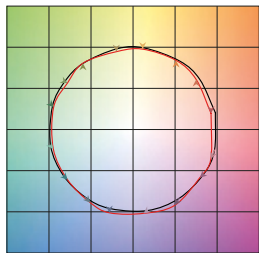

— Reference source  
— Test source

### 4,000 k

TM30		CRI	
RFR	g	Ra	R9
89	99	91	54

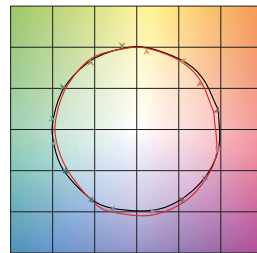

— Reference source  
— Test source

TM-30 se introdujo con la intención de proporcionar una nueva forma de medir la fidelidad de la luz y ayudar a los usuarios a analizar las características de color de las fuentes de luz de estado sólido modernas y tradicionales. Esto aporta una mayor equidad y precisión de la medición.

Como una métrica de color mejorada y más completa, podemos ver su valor para aquellos que necesitan detalles más precisos para medir la representación de color de varias fuentes de luz.



**DARK LINE SP 28 90**

**Optilux®**

**LC 34/690-825/50 0-10V fixC Ip SNC UNV**

**Control 0-10 V**

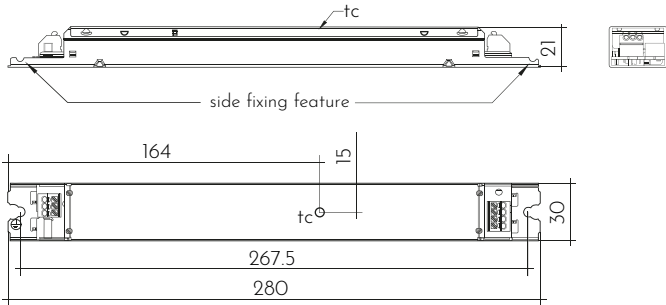

## Formación de Código

Código Base	Control	Corriente	IRC	Temp. de Color	Óptica	Reflector	Acabado
Modelo	0-10 V	1	690mA 690	<90 9	3000K 30	35° 35	Blanco B
	DALI	2	825mA 825		4000K 40	50° 50	Negro N
	bDW	3			80° 80	Metal M	Anodizado A
					~25 + 70° Asimétrico ZT25	O-D	
LTI2028.	1	825	9	30	O-D	N	N

## DATOS TÉCNICOS

MODELO: CÓDIGO BASE	LTI2028.											
Modulo LED	2x LLE 24x560mm 1500lm 930 LVD ADV1 - 28003490						2x LLE 24x560mm 1500lm 940 LVD ADV1 - 28003491					
Driver	LC 34/690-825/50 0-10V fixC Ip SNC UNV 87500862											
Óptica	35°	50°	80°	Haz Ovalado ~25 + 70°	ZT25 Haz asimétrico	35°	50°	80°	Haz Ovalado ~25 + 70°	ZT25 Haz asimétrico		
Temperatura de color	3000K						4000K					
Tolerancia de color (MacAdam)	3SDCM						3SDCM					
Corriente de operación (ajustable por switch ON)	690 mA   825 mA						690 mA   825 mA					
Flujo luminoso del sistema, lm (tp = 65°C)	4,090 lm   4,774 lm						4,270 lm   4,984 lm					
Eficacia del sistema (tp = 65°C)	135 lm/W   131 lm/W						141 lm/W   136 lm/W					
Flujo luminoso del luminario (tp = 65°C)*	3231   3771 lm	3108   3628 lm	3190   3724 lm	3027   3533 lm	3190   3724 lm	3373   3937 lm	3245   3788 lm	3331   3887 lm	3160   3688 lm	3331   3887 lm		
Rendimiento del luminario (maximo)	107 lm/W	103 lm/W	106 lm/W	100 lm/W	106 lm/W	112 lm/W	107 lm/W	110 lm/W	105 lm/W	110 lm/W		
Potencia del sistema	30.2 W   36.5 W						30.2 W   36.5 W					
Reproducción cromática (IRC)	Alta reproducción del color Ra > 90											
Interface de control	0-10 V / on/off											
Rango de Atenuación	10-100%											
Tensión de alimentación nominal ±10%	120 - 277 V~											
Frecuencia de red	50 / 60 Hz											
Protección contra sobretensiones	N/A											
Factor de Potencia λ (con 230 V, 60 Hz, plena carga)	> 0.95											
THD (con 230 V, 60 Hz, plena carga)	< 20 %											
Apto para picos de tensión (entre L/N - PE)	N/A											
Rango temperatura ambiente del sistema (ta)	-20 ... + 45 °C											
Vida útil nominal (L80/F10)	> 72.000 h											

\* Flujo luminoso tomado con una eficiencia del: 79% en 35° | 76% en 50° | 78% en 80° | 74% ~25 + 70° HAZ OVALADO | 78% ZT25 con Louver negro



La información descrita en esta ficha esta sujeta a cambios por actualizaciones.

Consulta las últimas especificaciones con tu asesor.

Technology +  
**TRIDONIC**

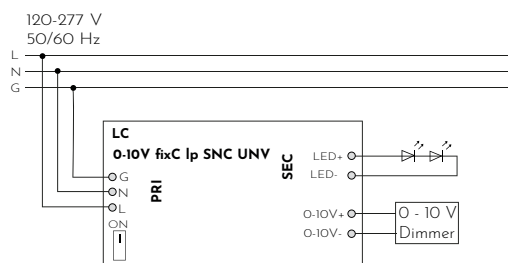

Press down the "push button" and remove the cable from front

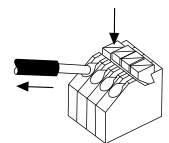

wire preparation:  
0.2 - 1.5 mm<sup>2</sup> (AWG24 - 16)  
8.5 - 9.5 mm (3/8 inch)

**Diagrama de Conexión**

LCA 45W 500-1400mA one4all SC PRE

CONTROL DALI

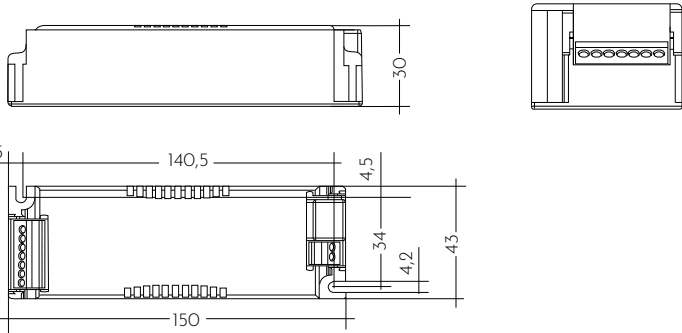

Formación de Código

Código Base	Control	Corriente	IRC	Temp. de Color	Óptica	Reflector	Acabado
Modelo	0-10 V 1	500mA 500	<90 9	3000K 30	35° 35	Blanco B	Blanco B
	DALI 2	1000mA 1000		4000K 40	50° 50	Negro N	Negro N
	bDW 3				80° 80	Metal M	Anodizado A
					~25 + 70° Asimétrico ZT25	O-D	A
LTI2028.	2	1000	9	40	A	N	B

DATOS TÉCNICOS

MODELO: CÓDIGO BASE	LTI2028.											
Modulo LED	2x LLE 24x560mm 1500lm 930 LVD ADV1 - 28003490						2x LLE 24x560mm 1500lm 940 LVD ADV1 - 28003491					
Driver	LCA 45W 500-1400mA one4all SC PRE 28000676											
Óptica	35°	50°	80°	Haz Ovalado ~25 + 70°	ZT25 Haz asimétrico	35°	50°	80°	Haz Ovalado ~25 + 70°	ZT25 Haz asimétrico		
Temperatura de color	3000K					4000K						
Tolerancia de color (MacAdam)	3SDCM					3SDCM						
Corriente de operación (ajustable por switch ON)	500 mA   1000 mA					500 mA   1000 mA						
Flujo luminoso del sistema, lm (tp = 65°C)	3,033 lm   5,746 lm					3,166 lm   5,999 lm						
Eficacia del sistema (tp = 65°C)	142 lm/W   133 lm/W					148 lm/W   139 lm/W						
Flujo luminoso del luminario (tp = 65°C)*	2396   4539 lm	2305   4367 lm	2366   4482 lm	2244   4252 lm	2366   4482 lm	2501   4739 lm	2406   4559 lm	2469   4679 lm	2343   4439 lm	2469   4679 lm		
Rendimiento del luminario (maximo)	112 lm/W	108 lm/W	110 lm/W	105 lm/W	110 lm/W	117 lm/W	112 lm/W	115 lm/W	109 lm/W	115 lm/W		
Potencia del sistema	21.4 W   43.2 W					21.4 W   43.2 W						
Reproducción cromática (IRC)	Alta reproducción del color Ra > 90											
Interface de control	one4all (DALI-2 DT 6, DSI, switchDIM, corredorFUNCTION)											
Rango de Atenuación	1-100%											
Tensión de alimentación nominal ±10%	220 - 240 V~											
Frecuencia de red	50 / 60 Hz											
Protección contra sobretensiones	320 V AC, 48 h											
Factor de Potencia λ (con 230 V, 60 Hz, plena carga)	0.96											
THD (con 230 V, 60 Hz, plena carga)	< 8 %											
Apto para picos de tensión (entre L/N - PE)	2 kV											
Rango temperatura ambiente del sistema (ta)	-25 ... + 45 °C											
Vida útil nominal (L80/F10)	> 72.000 h											

\* Flujo luminoso tomado con una eficiencia del: 79% en 35° | 76% en 50° | 78% en 80° | 74% ~25 + 70° HAZ OVALADO | 78% ZT25 con Louver negro

NOM DALI lumDATA IP20 SELV

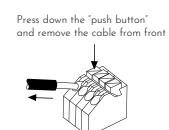
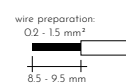
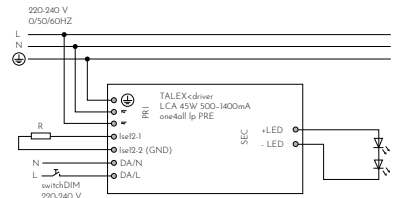
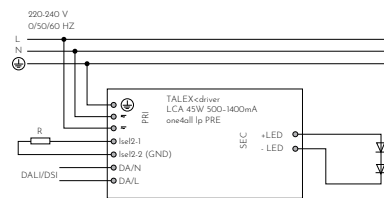

La información descrita en esta ficha esta sujeta a cambios por actualizaciones.

Consulta las últimas especificaciones con tu asesor.

**DARK LINE SP 28 90**

**Optilux®**

**LC 45/500-1400/50 bDW SC PRE2**

**CONTROL basicDIM Wireless**

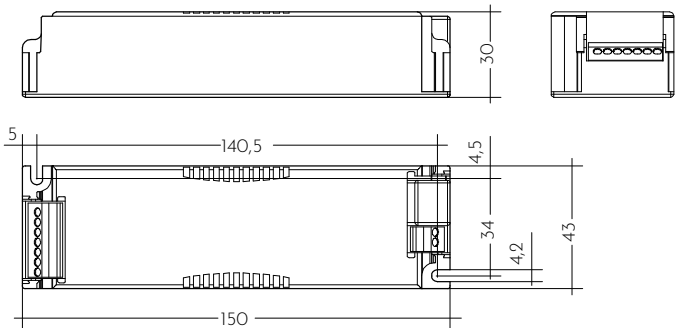

**Formación de Código**

Código Base	Control	Corriente	IRC	Temp. de Color	Óptica	Reflector	Acabado
Modelo	O-10 V 1	500mA 500	<90 9	3000K 30	35° 35	Blanco B	Blanco B
	DALI 2	1000mA 1000		4000K 40	50° 50	Negro N	Negro N
	bDW 3				80° 80	Metal M	Anodizado A
					~25 + 70° Asimétrico ZT25	O-D	A
LTI2028.	3	500	9	30	35	M	N

**DATOS TÉCNICOS**

MODELO: CÓDIGO BASE	LTI2028.											
Modulo LED	2x LLE 24x560mm 1500lm 930 LVD ADV1 - 28003490						2x LLE 24x560mm 1500lm 940 LVD ADV1 - 28003491					
Driver	LC 45/500-1400/50 bDW SC PRE2 28002414											
Óptica	35°	50°	80°	Haz Ovalado ~25 + 70°	ZT25 Haz asimétrico	35°	50°	80°	Haz Ovalado ~25 + 70°	ZT25 Haz asimétrico		
Temperatura de color	3000K					4000K						
Tolerancia de color (MacAdam)	3SDCM					3SDCM						
Corriente de operación (ajustable por switch ON)	500 mA   1000 mA					500 mA   1000 mA						
Flujo luminoso del sistema, lm (tp = 65°C)	3,033 lm   5,746 lm					3,166 lm   5,999 lm						
Eficacia del sistema (tp = 65°C)	142 lm/W   133 lm/W					148 lm/W   139 lm/W						
Flujo luminoso del luminario (tp = 65°C)*	2396   4539 lm	2305   4367 lm	2366   4482 lm	2244   4252 lm	2366   4482 lm	2501   4739 lm	2406   4559 lm	2469   4679 lm	2343   4439 lm	2469   4679 lm		
Rendimiento del luminario (maximo)	112 lm/W	108 lm/W	110 lm/W	105 lm/W	110 lm/W	117 lm/W	112 lm/W	115 lm/W	109 lm/W	115 lm/W		
Potencia del sistema	21.4 W   43.2 W					21.4 W   43.2 W						
Reproducción cromática (IRC)	Alta reproducción del color Ra > 90											
Interface de control	basicDIM Wireless (inalámbrico)											
Rango de Atenuación**	1-100%											
Tensión de alimentación nominal ±10%	220 - 240 V~											
Frecuencia de red	50 / 60 Hz											
Protección contra sobretensiones	320 V AC, 48 h											
Factor de Potencia λ (con 230 V, 60 Hz, plena carga)	0.96											
THD (con 230 V, 60 Hz, plena carga)	< 8 %											
Apto para picos de tensión (entre L/N - PE)	2 kV											
Rango temperatura ambiente del sistema (ta)	-25 ... + 45 °C											
Vida útil nominal (L80/F10)	> 72.000 h											

\* Flujo luminoso tomado con una eficiencia del: 79% en 35° | 76% en 50° | 78% en 80° | 74% ~25 + 70° HAZ OVALADO | 78% ZT25 con Louver negro

\*\* Puede ser integrado en sistemas Casambi (Casambi Ready)

Establece automáticamente una red de comunicación inalámbrica con hasta 250 nodos



La información descrita en esta ficha esta sujeta a cambios por actualizaciones.

Consulta las últimas especificaciones con tu asesor.

Technology +  
**TRIDONIC**

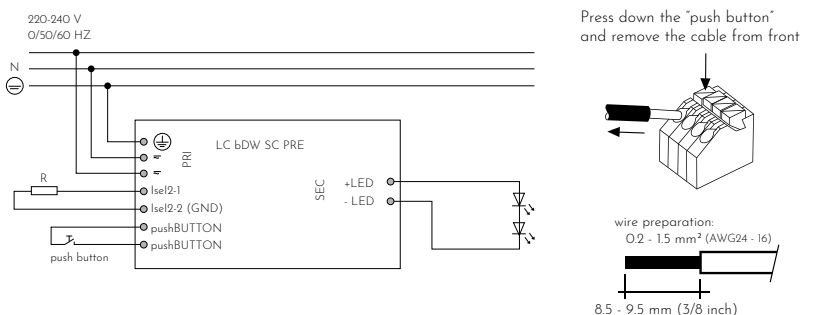

**Diagrama de Conexión**

# Optilux<sup>®</sup>

[contacto@optilux.mx](mailto:contacto@optilux.mx)

Tel: 55-9133-3136



Síguenos en: [@optiluxmx](https://www.instagram.com/optiluxmx)